

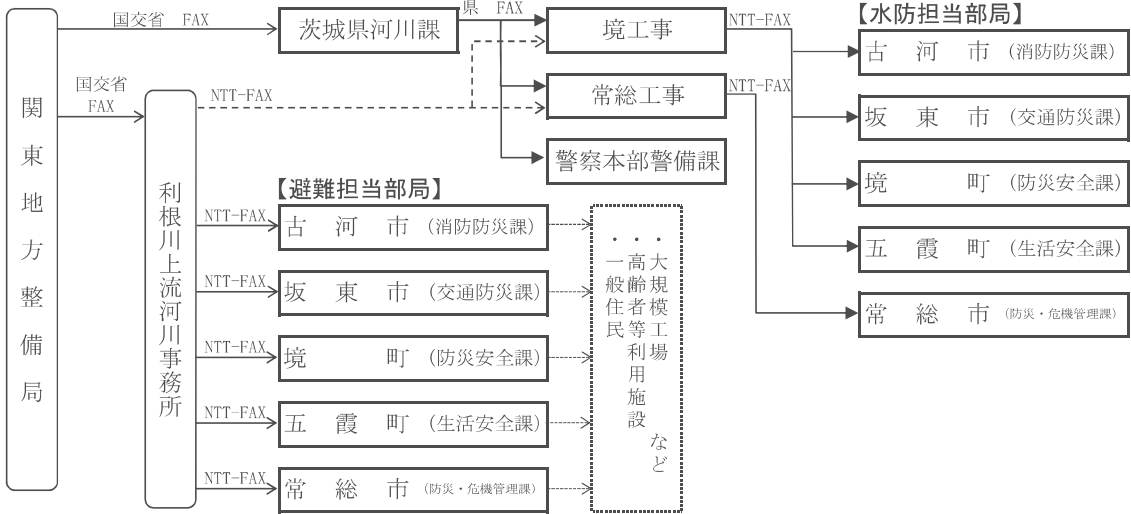

(2)河川管理者(関東地方整備局長)の伝達系統



1 利根川上流部



2 利根川中流部

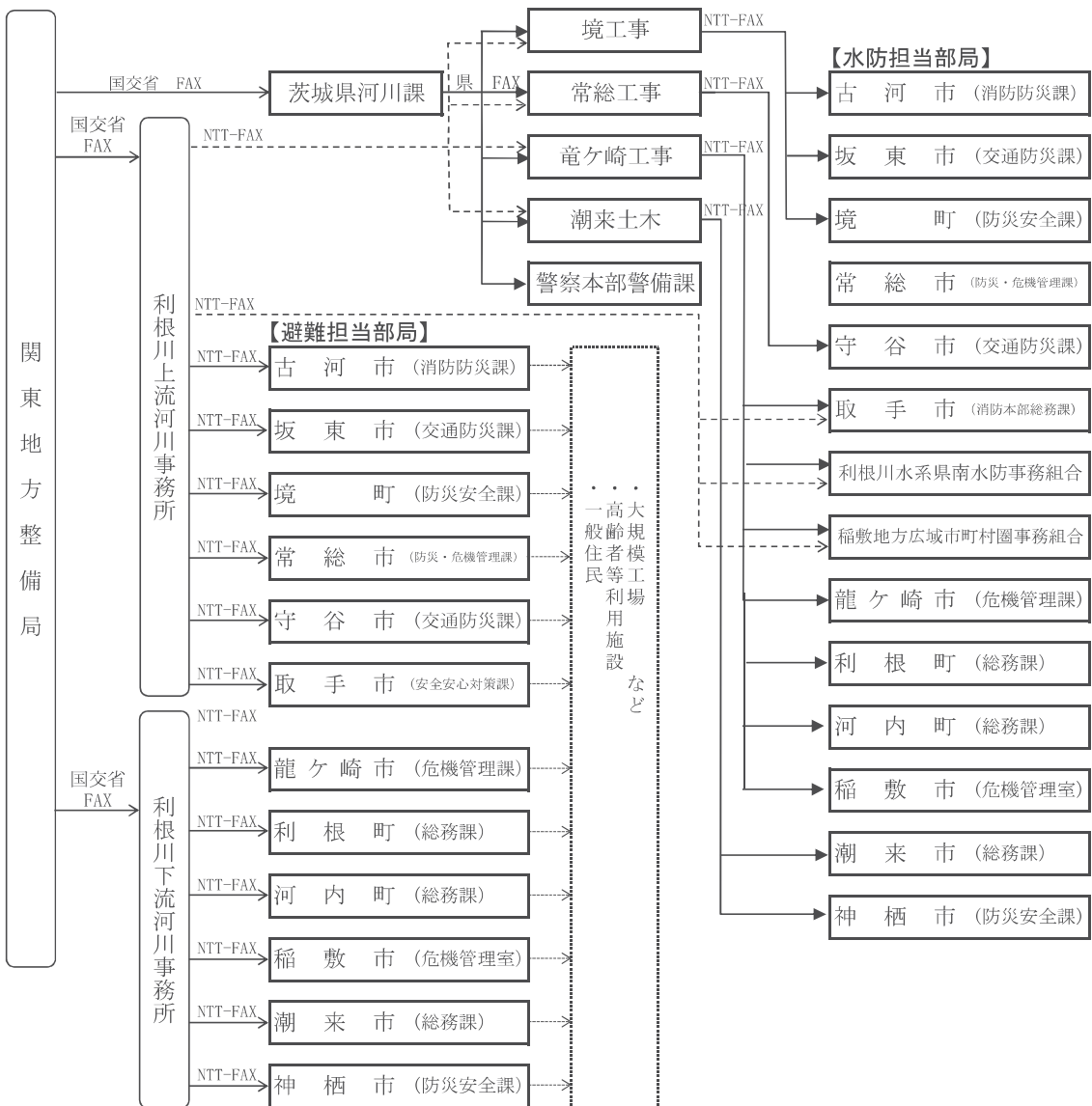

3 利根川下流部

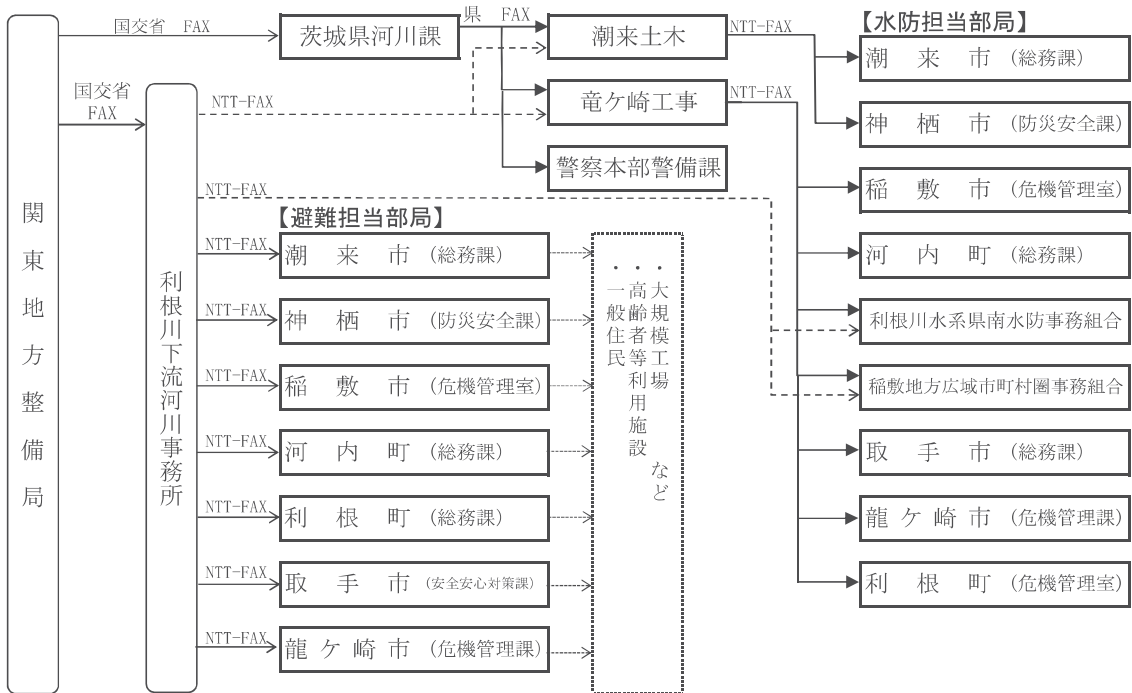

4 渡良瀬川下流部

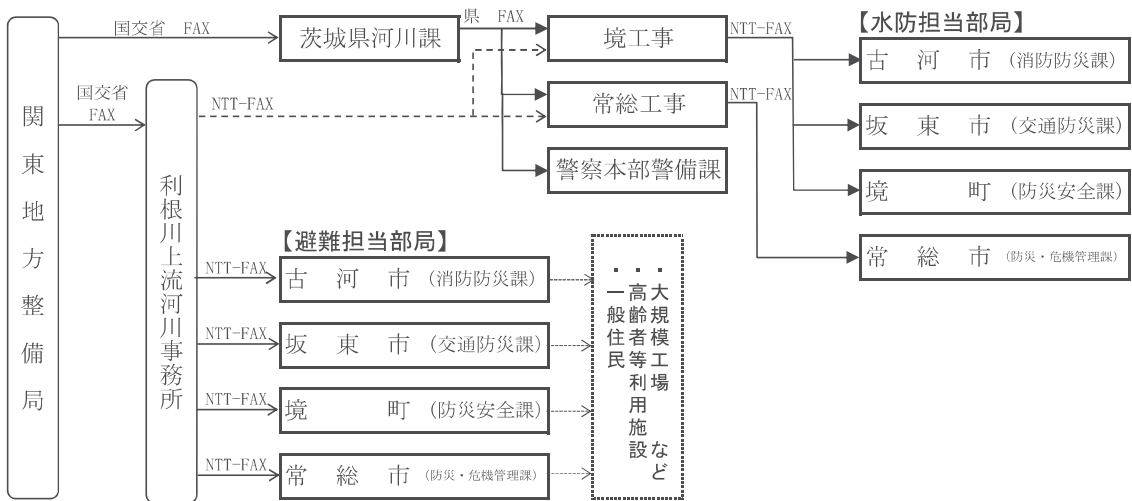

5 江戸川

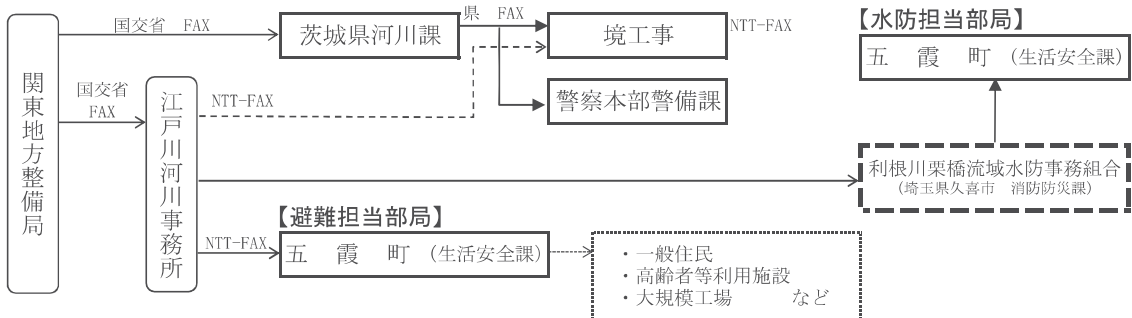

6 霞ヶ浦・北浦

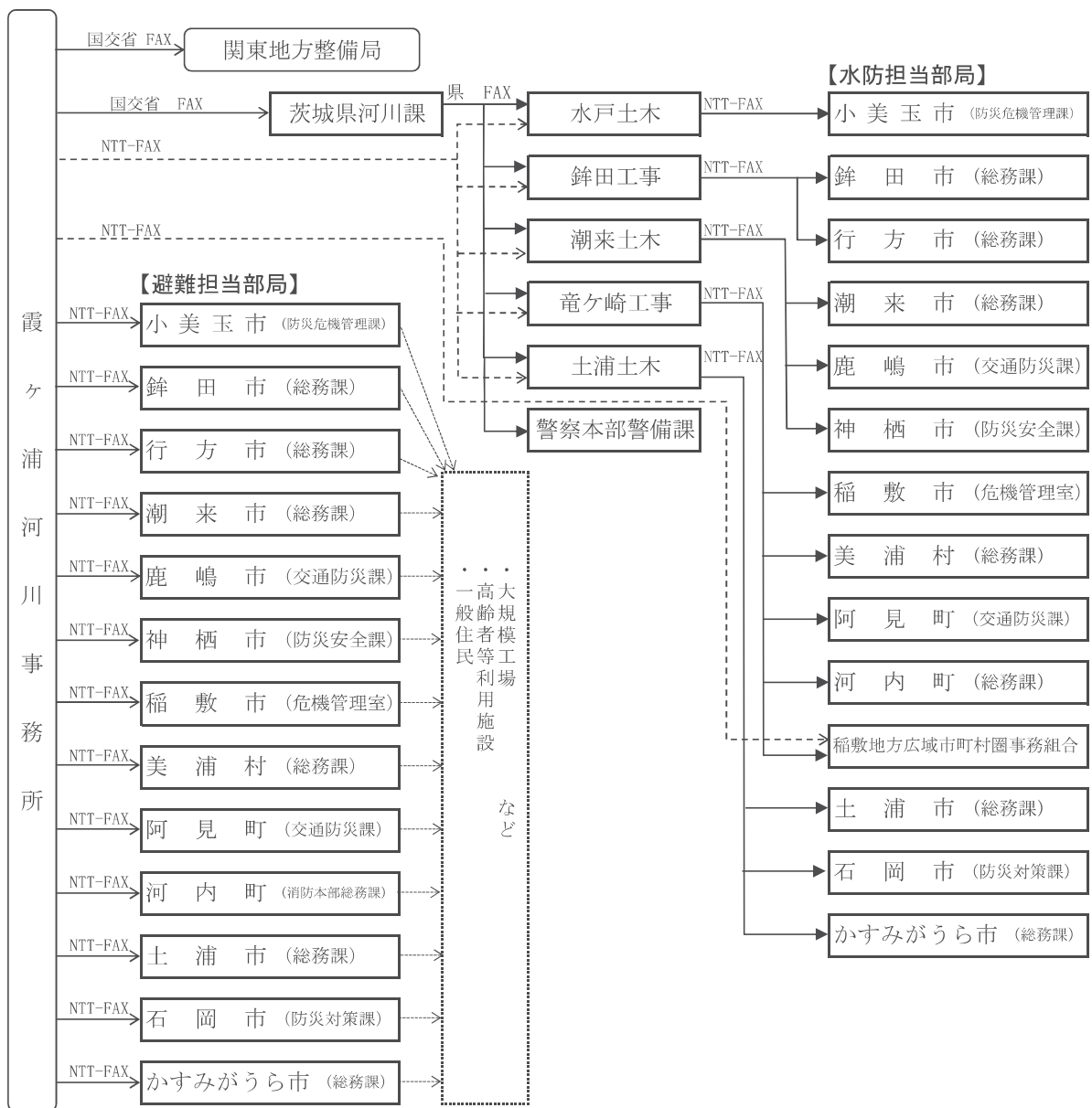

7 鬼怒川

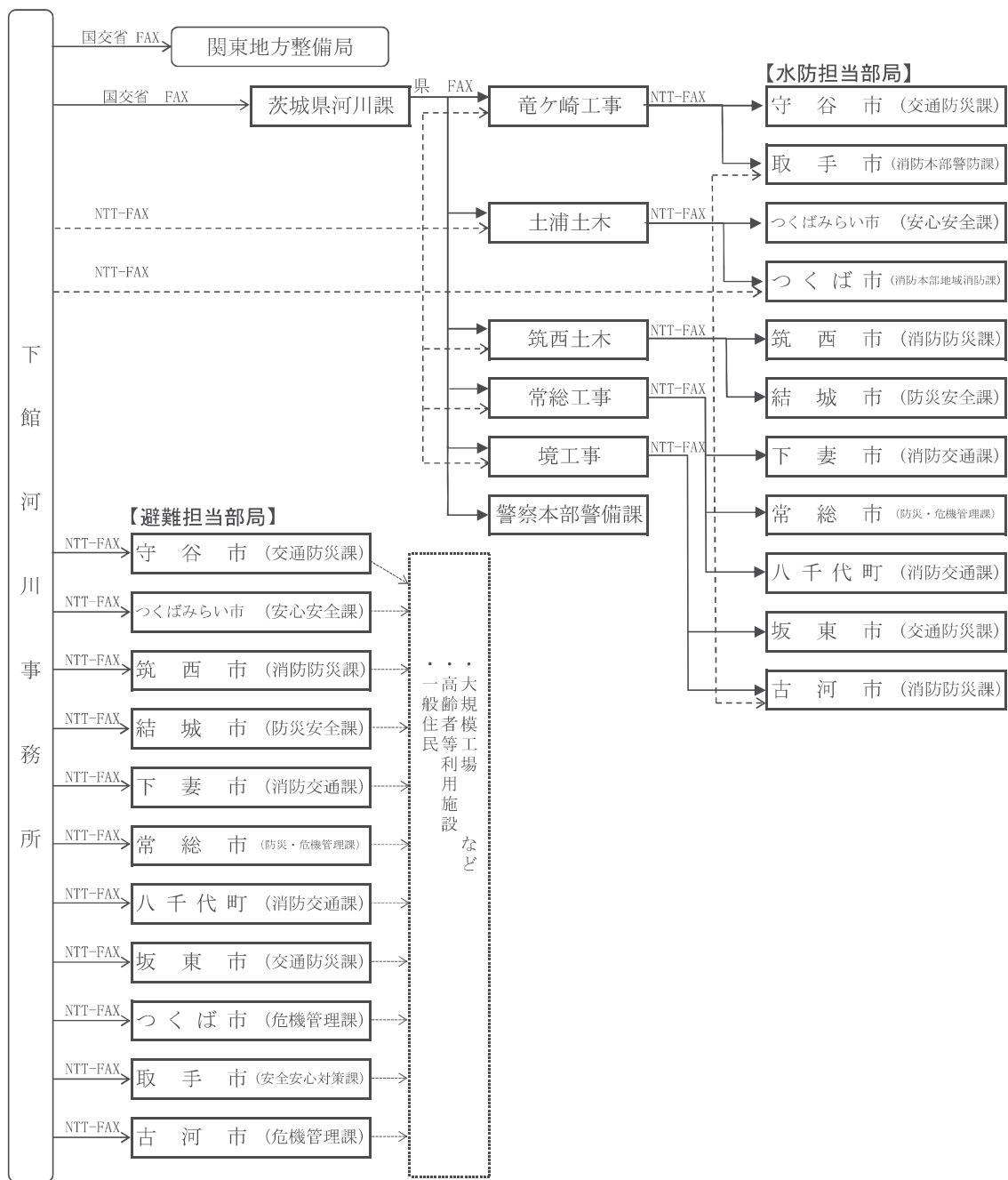

8 小貝川

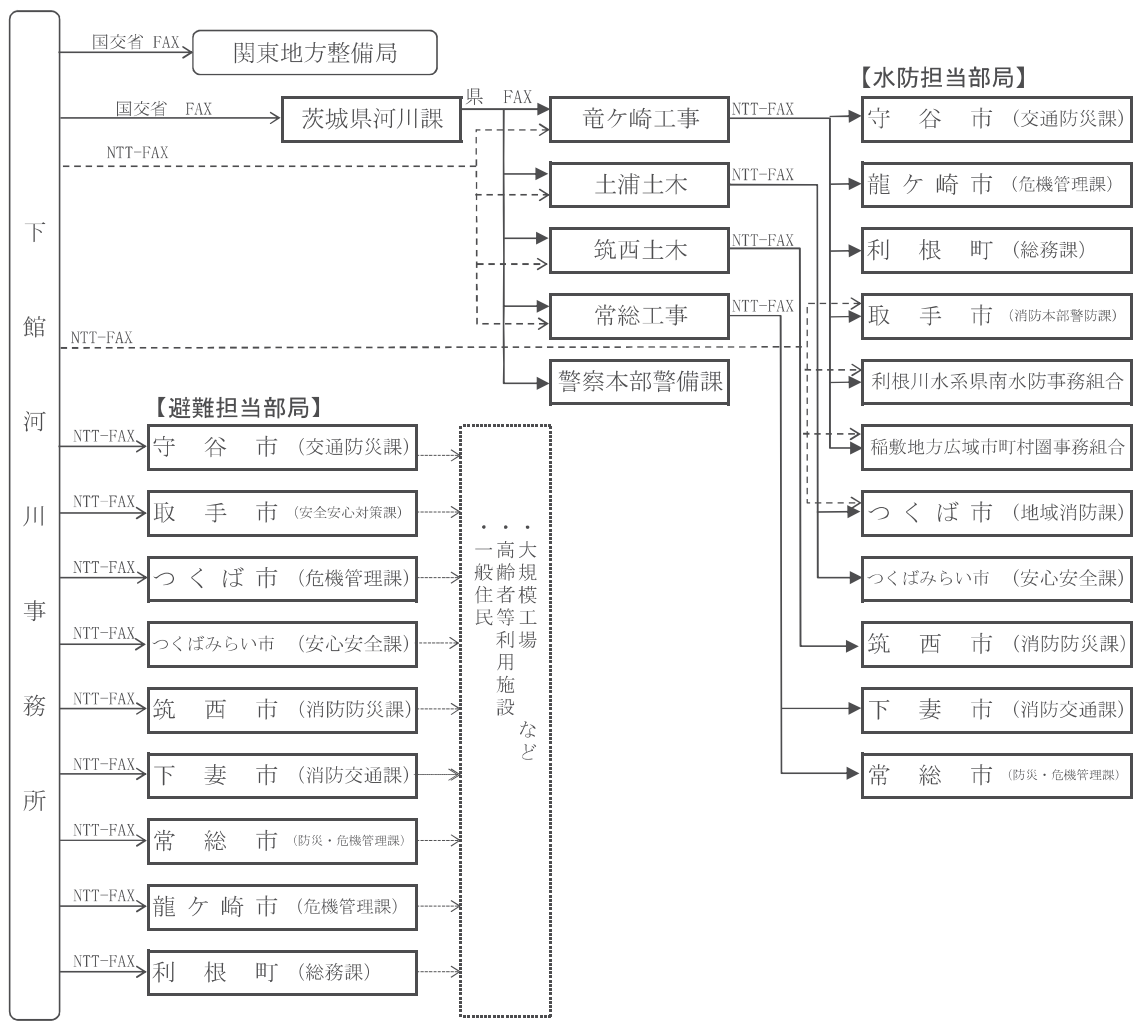

9 那珂川

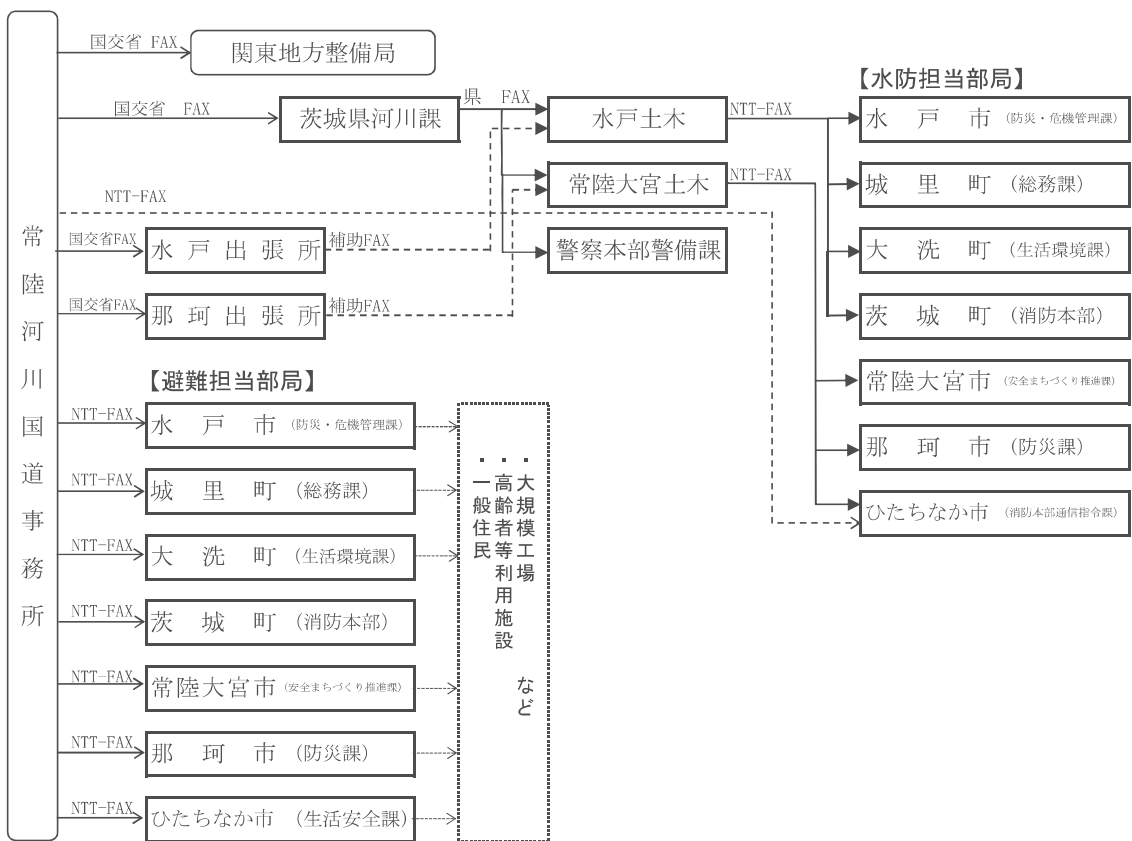

10 久慈川

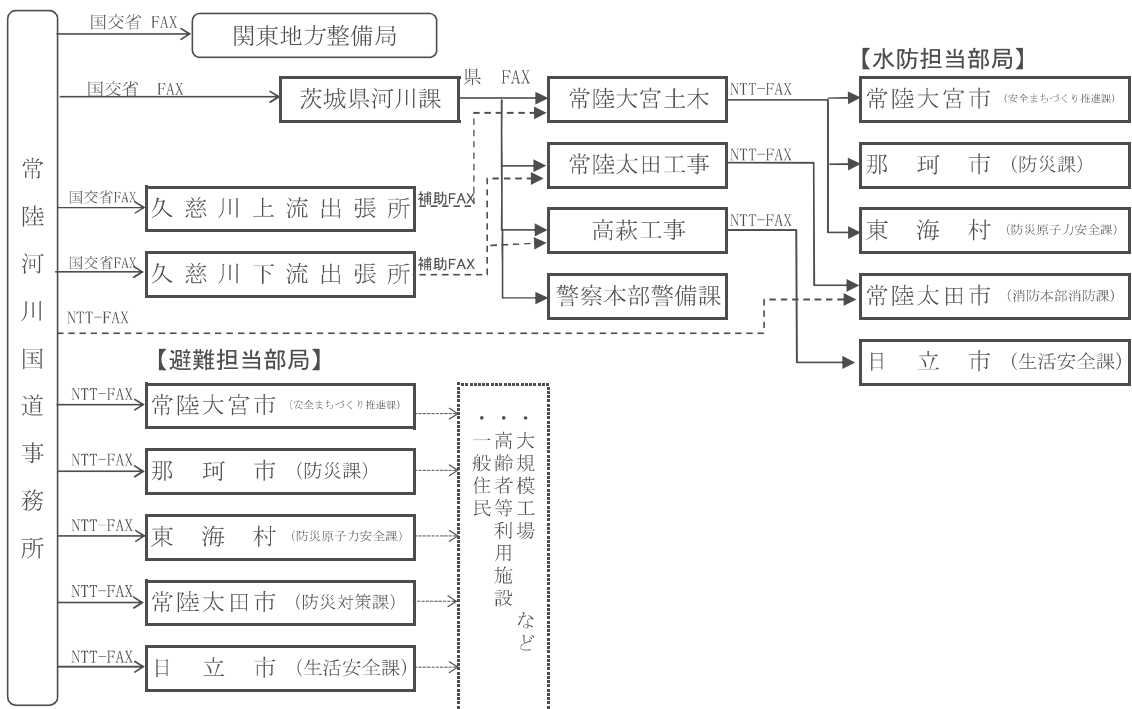

(3)河川管理者(知事)の伝達系統



1 利根川水系桜川

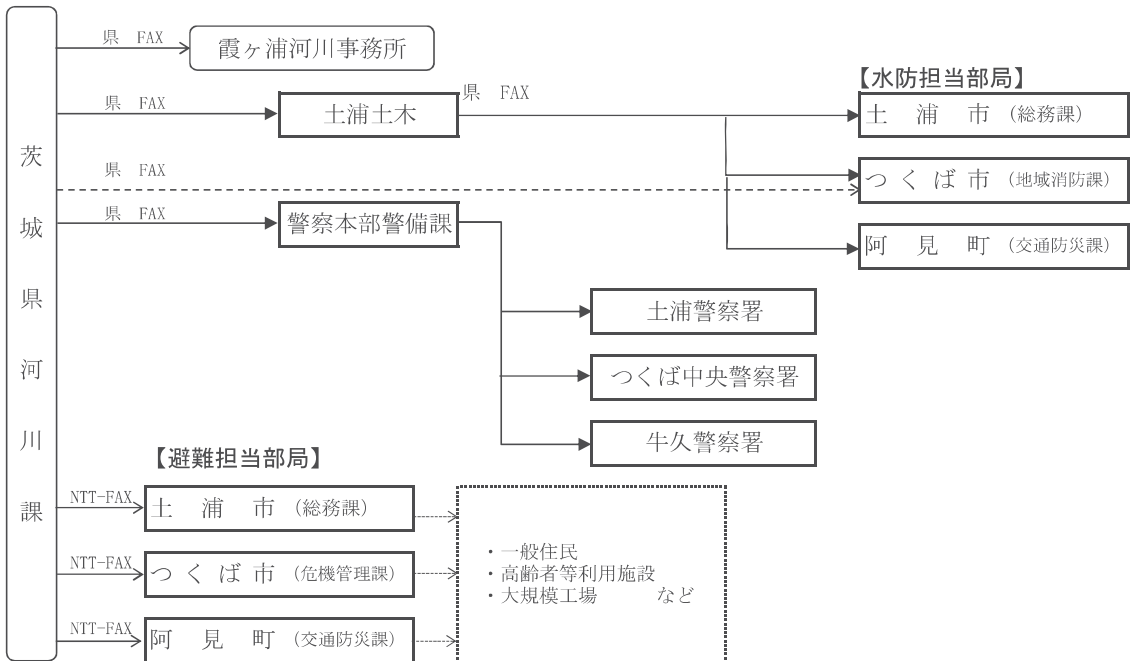

2 五行川【栃木県管理区間発表による】

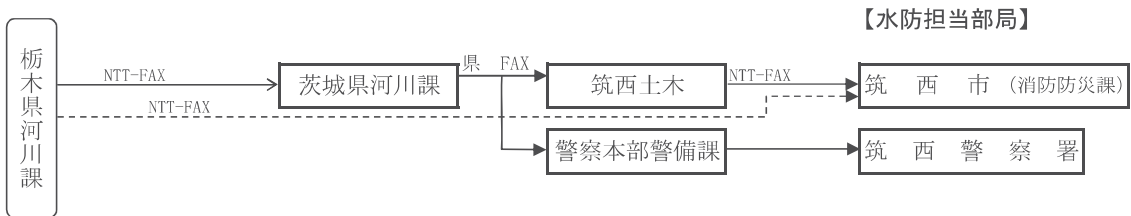

3 田川【栃木県管理区間発表による】

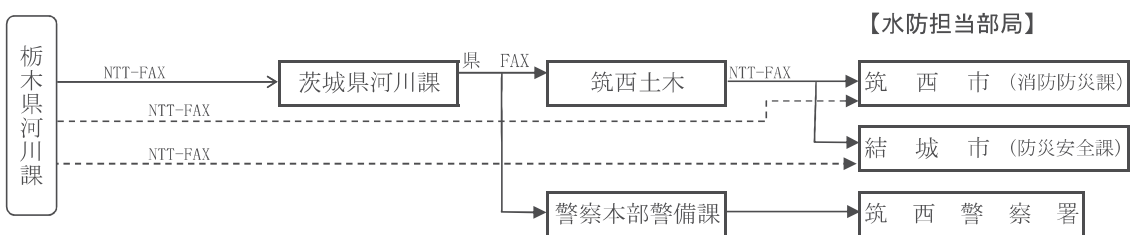

4 思川【栃木県管理区間発表による】

